

## stenentransportklem - pince de transport de pavés - Stone transportation clamp - Steintransportklammer

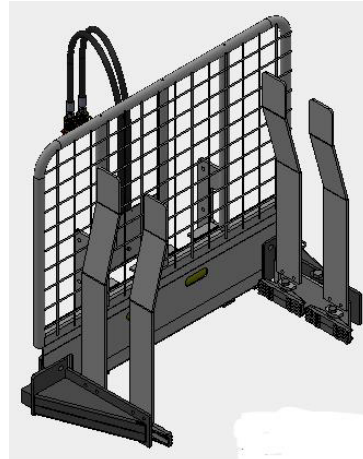

20099239

20409223

Art. nr.

Type

20099239

KM 80  
KM 85  
KM 90  
KM 100

20409149 (\*)

KM 120  
KM 125  
KM 130  
KM 140  
KM 180  
KM 250

20409223 (\*)

All

## Benodigdheden/nécessités/necessities/Notwendigkeiten (\*)

20099305

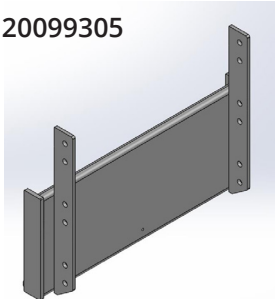

20251100

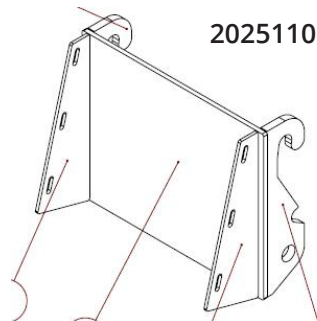

Art. nr.

Type

20099305

KM 80  
KM 85  
KM 90  
KM 100

20139304

KM 120  
KM 125  
KM 130  
KM 140

20251100

KM 180  
KM 250

20139304

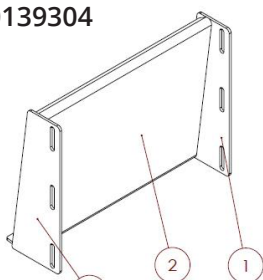

Beschikbaar met/disponible avec/available with/verfügbar mit

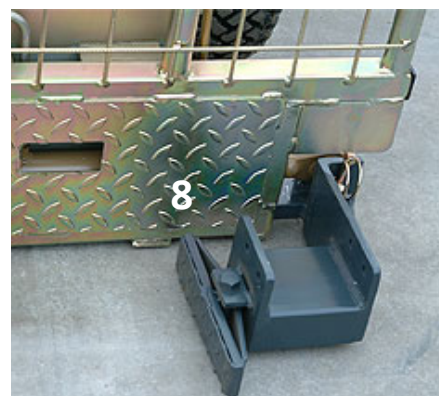
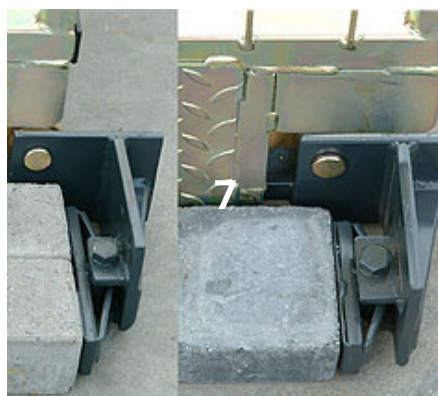
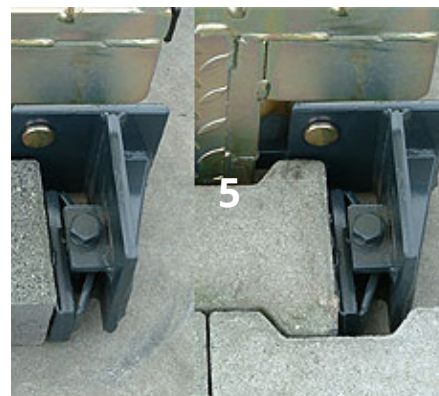
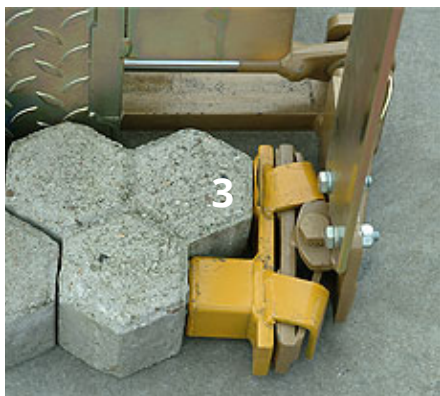

nr.	Art. nr.	Stensoort	klembreedte
1	R: 20509229 L: 20509228	S klinkers	
2	R: 20509231 L: 20509230	Stenen 15x15 cm	
3	R: 20509233 L: 20509232	Drievoudige zeshoek- steen	
4	R: 20509235 L: 20509234		
5	R: 20509282 L: 20509147	Stenen 15x15 cm H stenen	
6	R: 20509087 L: 20509237	Stenen 40x40 cm Stenen 60x60 cm	100 cm - 134 cm
7	R: 20509291 L: 20509292		100 cm - 134 cm
8	R: 20509279 L: 20509281		50 cm - 84 cm
9	R: 20509123 L: 20509122	30x30 cm	140 cm - 174 cm
10	R: 20509279 L: 20509281		50 cm - 84 cm
11	R: 20509278 L: 20509280		80 cm - 114 cm